

# Development of the Regenerative Power Compensation Device “SANUPS K23A (R Type)”

Takuya Ota    Yoshiaki Okui    Naoya Nakamura    Mitsuru Takasugi

## 1. Introduction

In recent years, energy saving has grown in various fields to reduce CO<sub>2</sub> emissions. Fields that use motors account for approximately 57%, or about half, of Japan’s total power consumption <sup>(1)</sup>. Therefore, there are great expectations for reductions in CO<sub>2</sub> emissions through energy saving measures for power consumption in these fields.

As energy saving measures when using motors, there have been various initiatives including improving the inverter implementation rate for motors or improving the motor efficiency. In particular, regenerative power is often used in applications with repeated acceleration and deceleration at high inertia or changes in potential energy such as in conveyors. Reworking this process is one effective type of energy saving measure.

With this in mind, we developed the regenerative power compensation device “SANUPS K23A (R Type)” that can effectively use regenerative power in motor drive systems. This document introduces these features.

## 2. Motor Drive System and Regenerative Power Compensation Device

Fig. 1 shows the motor drive system with an inverter drive. Many current systems convert AC power to DC using a diode rectifier as shown in (a), and the motor is controlled through VVVF controls from the inverter using DC power. However, diode rectifiers are unidirectional converters that cannot perform power conversion on the power source side, so regenerative power is consumed as heat energy by the control resistor. In this way, the overall system efficiency falls due to the regenerative power being consumed by heat.

With this in mind, the power regenerative system shown in (b) uses a PWM converter instead of a diode rectifier

for a system that can return regenerative power to the power supply. In this situation, regenerative power is not consumed as heat, so the overall efficiency of the system improves.

Furthermore, as shown in (c), a AC to AC direct converter called a “matrix converter” was developed for a system that drives motors with one converter from AC power.

In the system shown in Fig. 1 (b) and (c), the running power during motor driving (during power running) and regenerative power during motor decelerating enlarge the power fluctuation on the power supply, resulting in worsening of power quality on the power distribution system and enlargement of the power distribution equipment.

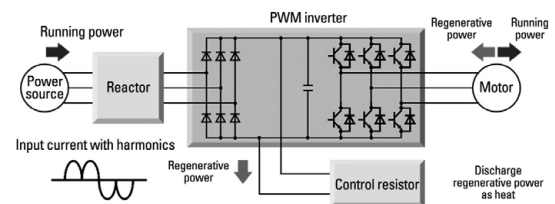

(a) Regeneration resistance discharge system

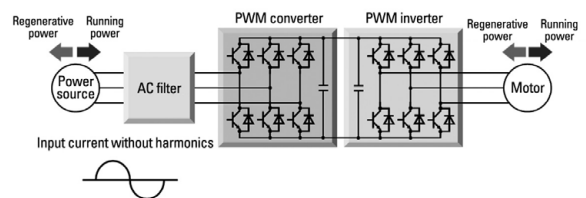

(b) Power regenerative system

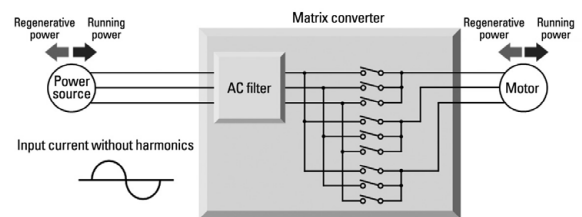

(c) Matrix converter system

Fig. 1: Motor drive system

With this in mind, the newly developed regenerative power compensation device “SANUPS K23A (R Type)” not only returns regenerative power to the power supply side, but the regenerative power also momentarily charges the storage device in the system and this stored energy can be used during the next power running. With this, the motor drive system can reduce the power used and the received power. Fig. 2 shows the operating image. By using regenerative power for the next running power, the received power can be reduced.

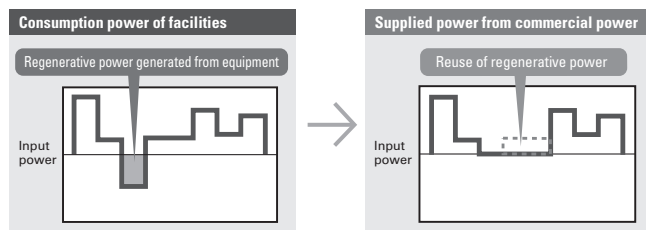

Fig. 2: Image of regenerative power compensation

### 3. Characteristics of “SANUPS K23A (R Type)”

#### 3.1 Basic structure

This equipment uses electric double layer capacitors (EDLC) as the storage element and the device output model comes in two types: AC type and DC type.

#### 3.2 Characteristics of the AC type

Fig. 3 shows the basic circuit structure of the AC type. The AC type connects a sine wave PWM method AC/DC converter in parallel to the commercial power. Running power and regenerative power charges and discharges the EDLC via the AC/DC converter.

This AC type can be adapted into systems such as Fig. 1 (c) matrix converters and it can compensate regenerative power with AC. This AC type has a shape that can be inserted into currently established power distribution lines, so it can be introduced with relative ease.

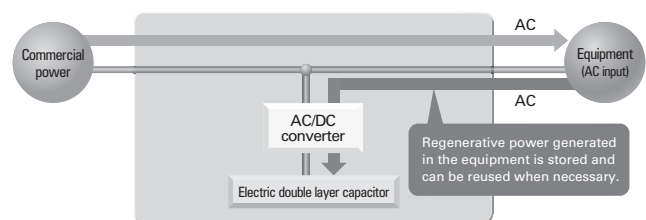

Fig. 3: Basic circuit structure of the AC type

#### 3.3 Characteristics of the DC type

Fig. 4 shows the basic circuit structure of the DC type. The DC type connects a sine wave PWM method AC/DC converter to the commercial power and obtains DC output while converting the input current into a sine wave. Furthermore, a DC/DC converter is connected to the DC output line, and like the AC type, the EDLC is used for charging and discharging.

By charging and discharging the EDLC via the DC/DC converter, the operating voltage range for the EDLC widens and the utilization rate is increased, so the device can be made smaller.

This DC type compensates with regenerative power near the DC inverter, and the utilization efficiency of the regenerative power is increased.

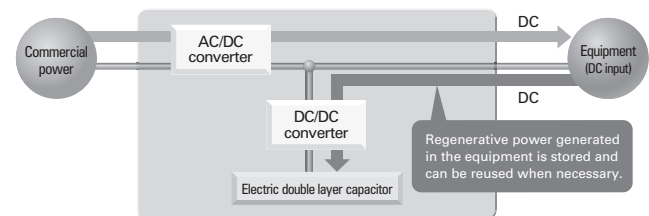

Fig. 4: Basic circuit structure of the DC type

When introducing this DC type into a previously established system as shown in Fig. 1 (a), the device can be introduced by removing the drive unit and drive resistor and connecting the outputs for this device into the same terminals. This device can be introduced into a new system in place of the PWM converter shown in Fig. 1 (b). This device can add regenerative power compensation within the drive system.

Fig. 5 shows an application example when using multiple motor inverters. When using multiple motor inverters, the charge and discharge power is compensated by each motor in the DC part, so the AC/DC converter can be made smaller and only one converter is required, which makes it easier to see the benefits.

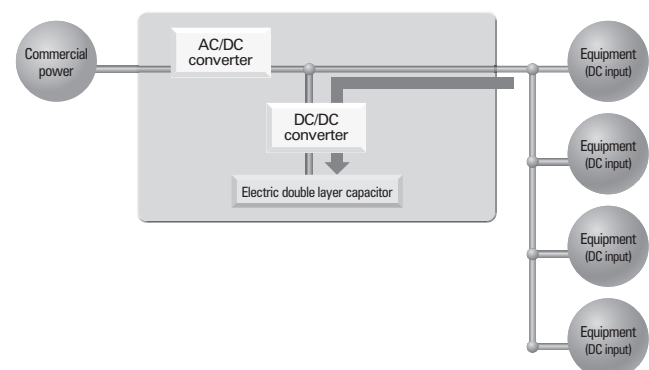

Fig. 5: Example applications of multiple motor inverters

### 3.4 Peak-cut function

Fig. 6 shows an example of the drive pattern for this device. This device not only charges the EDLC using regenerative power, but it also has a peak-cut function <sup>(2)</sup><sup>(3)</sup>.

This peak-cut function is a function that establishes limits for received commercial power and discharges (assists) with power from the EDLC when there is insufficient power.

This figure shows operations when AC power is set (peak-cut) to become 8 kW. As a result, the load pattern in this figure obtains the following results.

Input peak power 68% cut (25 kW to 8 kW)

Input power 46% reduced (870 kW to 470 kW)

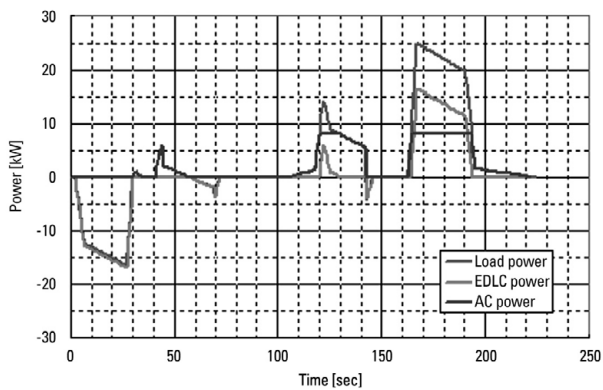

Fig. 6: Example of drive pattern

## 4. Overview of Specifications

Table 1 shows the basic specifications. Furthermore, Fig. 7 shows the appearance of the developed “SANUPS K23A (R Type)”. The converter capacity for the AC/DC converter and DC/DC converter is continuous rated 20 kW and maximum 30 kW (30 s). Furthermore, with two units operating in parallel, regenerative power compensation of 40 kW (maximum 60 kW) is possible. The table indicates the maximum output capacity using the device output capacity (power that can be supplied from the inverter).

Fig. 8 shows the display system for energy saving effects. The energy saving effects can be displayed using a computer with RS-485 communications.

Application examples include elevator parking garages, as the device has a separate converter and EDLC which can be separated for a thin, space-saving design that can be flexibly positioned in a small parking space.



Fig. 7: Developed “SANUPS K23A (R type)”

Table 1: Basic specifications

AC output

Model		K23AA203	K23AA403	Remarks	
Input	No. of phases/wires	Three phase, three wire			
	Rated voltage	AC 200 V			
	Rated frequency	50/60 Hz			
Output	Type	AC			
	Rated voltage	Same as AC input			
	AC/DC converter	Rated capacity	20 kW	40 kW	Operation time: 30 s, Cycle: 180 s
		Max. capacity	30 kW	60 kW	
Max. total output capacity	75 kW	150 kW			
Storage element		Electric double layer capacitor			

DC output

Model		K23AD203	K23AD403	Remarks	
Input	No. of phases/wires	Three phase, three wire			
	Rated voltage	AC 200 V			
	Rated frequency	50/60 Hz			
Output	Type	DC			
	Rated voltage	350 V			
	AC/DC converter	Rated capacity	20 kW	40 kW	Operation time: 30 s, Cycle: 180 s
		Max. capacity	30 kW	60 kW	
	DC/DC converter	Rated capacity	20 kW	40 kW	Operation time: 30 s, Cycle: 180 s
		Max. capacity	30 kW	60 kW	
Max. total output capacity	60 kW	120 kW			
Storage element		Electric double layer capacitor			



Energy saving effects  
and  
remaining capacitor  
capacity information

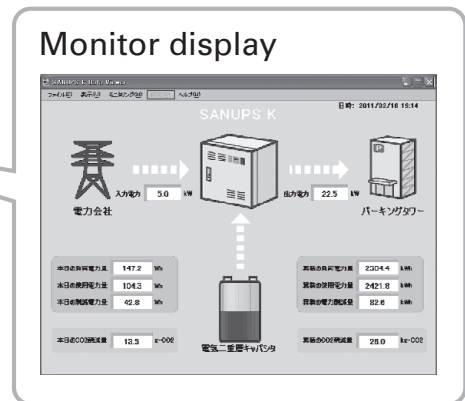

Fig. 8: Display system for energy saving effects

## 5. Conclusion

This document introduced the product overview of the regenerative power compensation device "SANUPS K23A (R Type)" that uses electric double layer capacitors.

This product is one that provides energy saving measures for motor drive systems, and we hope that it can contribute to energy savings in this field.

### Documentation

- (1) Fuji Keizai: "Current and Near-Future Trends in Power Consumption of Power Using Devices", Report No. 110812206 (2009)
- (2) Okui: "High Quality and High Performance Voltage Dip Compensator", Green Technology Vol. 19 No. 7 (2009)
- (3) Okui and Others: "Development of the High Performance Voltage Dip Compensator 'SANUPS C23A'" SANYO DENKI Technical Report Issue 27, pages 16-20 (2009).

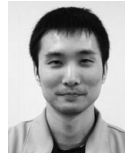

### Takuya Ota

Joined Sanyo Denki in 2009.  
Power Systems Division, 1st Design Dept.  
Worked on the development and design of UPS.

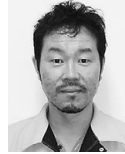

### Yoshiaki Okui

Joined Sanyo Denki in 1992.  
Ph.D. (Engineering)  
Power Systems Division, 1st Design Dept.  
Worked on the development and design of power converters, such as UPS.



### Naoya Nakamura

Joined Sanyo Denki in 1998.  
Power Systems Division, 1st Design Dept.  
Worked on the development and design of UPS.



### Mitsuru Takasugi

Joined Sanyo Denki in 1988.  
Power Systems Division, 1st Design Dept.  
Worked on the structural design of UPS.